



***Congratulations on your decision to enjoy the finest spa available...
Welcome to the growing family of Hot Spot® Spa owners.***

2003 Pre-Delivery Instructions

Please take the time to read this booklet carefully, as it will provide you with the information you will need to ensure the safe, secure, and timely installation of your new spa. The following sections are guidelines on how to prepare for delivery and set-up of your new spa. Specifically covered are site selection, delivery access, ground preparation, and electrical requirements.

Remember to carefully read the Owner's Manual that accompanies your spa, and to complete the warranty card within 10 days of delivery. These items, along with other valuable information, will be found in the Owner's Package which has been placed in the equipment compartment of your spa, where you will also find its serial number.

Watkins Manufacturing Corporation reserves the right to change features, specifications and design without notification and without incurring any obligation.

DATE PURCHASED: _____

DATE INSTALLED: _____

DEALER: _____

ADDRESS: _____

TELEPHONE: _____

In most cities and counties, permits will be required for the installation of electrical circuits or the construction of exterior surfaces (decks and gazebos). In addition, some communities have adopted residential barrier codes which may require fencing and/or self-closing gates on the property to prevent unsupervised access to a pool (or spa) by children under 5 years of age. Your Hot Spot spa is equipped with a locking cover that meets the ASTM F1346-91 Standard for Safety Covers and as a result, is usually exempt from most barrier requirements. As a general practice, your local Building Department will inform you of any applicable barrier requirements at the time a permit is obtained for the installation of an electrical circuit. Your Hot Spot dealer can provide information on which permits may be required.

Hot Spot Spa Pre-Delivery Instructions

SITE SELECTION AND PREPARATION

IMPORTANT: Site selection and preparation are your responsibility. Carefully read these instructions and consult your authorized Hot Spot® dealer if you have any questions.

You probably have a spot picked out for your new spa, whether it's indoors or outdoors, on a patio or on a deck. Just make sure you check the following:

- Always put your spa on a structurally sound, level surface. A filled spa can weigh a great deal. Make certain that the location you choose can support the weight of your filled spa.
- Locate your equipment compartment, which houses all of the electrical components, in a place where water will drain away from it. Allowing water into the equipment compartment can damage the electronics, or may result in tripping your house's circuit breaker.
- Leave yourself easy access to the circuit breakers in the subpanel (when connected to 230 volts), or to the interrupter switch by the end of the power cord (115 volt models).
- Never let water get into the subpanel (when connected to 230 volts), into the interrupter switch (115 volt models), or into the electrical outlet that your spa is plugged into.
- Leave access to the entire front of the spa (the removable panels provide access to the spa's equipment) for periodic spa care and maintenance.

OUTDOOR AND PATIO INSTALLATION

No matter where you install your new spa, it's important that you have a solid foundation to support it. Structural damage to the spa resulting from incorrect installation or placement on an inadequate foundation is not covered under the spa's limited warranty.

If you install the spa outdoors, a reinforced concrete pad at least four inches thick is recommended for your Hot Spot Spa. The reinforcing rod or mesh in the pad should be attached to a bond wire (see your Owner's Manual).

If you place the spa on the ground, even temporarily, place stepping stones under the leveling areas. The stones should be at least two inches thick and twelve inches square. Even with stones in place, the spa will inevitably settle and become unlevel. Plus, a spa surrounded by dirt or grass will soon be filled with dirt or grass from users' feet; therefore, it is important to get it onto a solid foundation as soon as possible.

DECK INSTALLATION

To be certain your deck can support your spa, you must know the deck's maximum load capacity. **Consult a qualified building contractor or structural engineer before you place the spa on an elevated deck or indoors.** To find the weight of your spa, its contents and occupants, refer to the Spa Specification chart. This weight per square foot must not exceed the structure's rated capacity, or serious structural damage could result.

INDOOR INSTALLATION

Be aware of some special requirements if you place your spa indoors. Water will accumulate around the spa, so flooring materials must provide a good grip when wet. Proper drainage is essential to prevent a build-up of water around the spa. When building a new room for the spa, it is recommended that a floor drain be installed. The humidity will naturally increase with the spa installed. Water may get into woodwork and produce dryrot, mildew, or other problems. Check for airborne moisture's effects on exposed wood, paper, etc. in the room. To minimize these effects, it is best to provide plenty of ventilation to the spa area. An architect can help to determine if more ventilation must be installed.

Your Hot Spot dealer can help you with local information such as zoning regulations and building codes.

DELIVERY ACCESS

First, locate the dimensions of your spa on the following chart. The dimensions shown are the measurements of the spa in the vertical position, laid on its side.

Next, contact your dealer to find the height and width added by the delivery cart which the dealer will use to deliver your new spa. Use the height of the cart plus the dimension shown as H to determine the vertical clearance required to pass the spa and cart. Use the width of the cart, or dimension W, whichever is greater, to determine the maximum width of clearance necessary.

NOTE: It may be necessary to allow for additional overhead clearance if the spa will be rolled up or down an incline or moved up or down a short flight of stairs.

Use the information below to determine the requirements for access to your desired location.

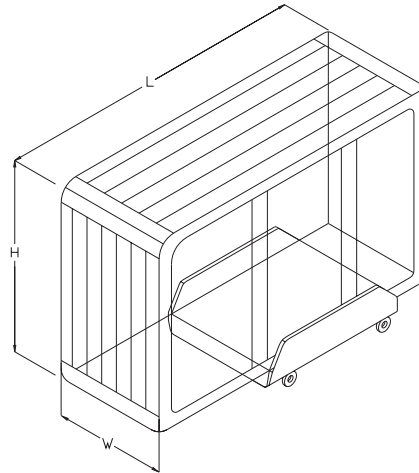

Model	Width W	Length L	Height H
Mallorca (MAL)	36"	84"	84"
Sorrento (SOR)	36"	78"	78"
Trinidad (TRI)	34"	80"	70"
Tobago (TOB)	29"	80"	70"

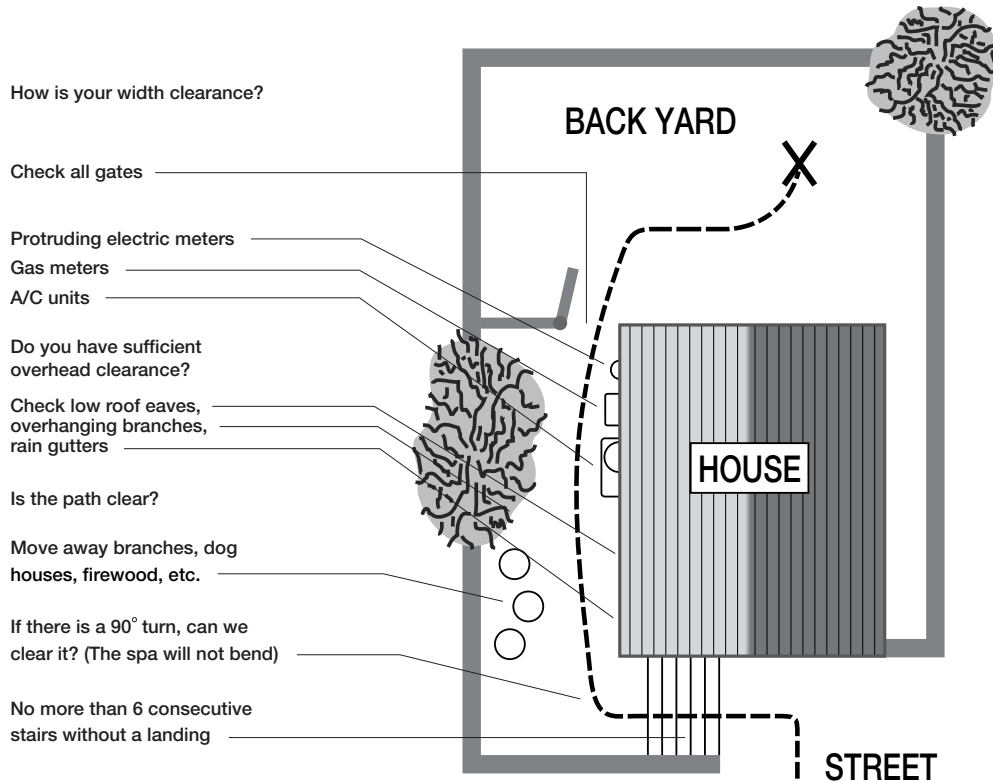

It may be necessary to remove a gate, part of a fence, or other movable obstructions in order to roll the spa to its installation site. About ten percent of the time, a crane is the only way to install the spa by lifting it to its final destination.

If the spa has to be taken off the cart to go over a wall (either because the entry area is too narrow, the eaves are too low, the corner is too tight, or the stairway is too steep), a crane will be required. Don't be alarmed!

The crane has a truck-mounted boom which can fit right in your driveway. It is run by a licensed and insured operator. For a charge, the crane operator will lift your spa over walls, buildings, or any other obstruction and place it as close to the installation site as possible. The Hot Spot® spa delivery personnel will supervise the crane delivery and complete the spa installation. Crane delivery typically takes an average of 30 minutes to complete.

NOTE: If your spa delivery requires the use of a crane, you may be required to pay for its services at the completion of the delivery.

GROUND PREPARATION

Your Hot Spot spa has been engineered to perform on all kinds of common yard surfaces. While a concrete slab is best for long-term use*, other foundations are acceptable so long as a level base is prepared prior to delivery. Three foundation base pictures, shown at right, represent examples of alternatives to a concrete slab for spas installed without gazebos or other accessories.

***NOTE:** A reinforced concrete pad at least four inches thick or structurally sound deck able to support the "dead weight" found in the spa specification chart is recommended for your Hot Spot spa.

INSTALLATION NOTES:

- If stepping stones or railroad ties are selected for the spa foundation, they should be placed at the designated leveling areas of your spa to maintain even distribution of the spa weight.
- It is important to note that soft surfaces, even when stepping stones are used to distribute the weight of the spa as evenly as possible, will still have a tendency to settle unevenly, resulting in an unlevel spa.
- Remember, placing the spa on grass or dirt may increase the amount of debris which is inadvertently brought into the spa water on the user's feet.

If you are purchasing a deck package or a gazebo with your spa, a solid foundation becomes mandatory. Placing them on any surface other than a single level pad could create problems with their installation. Pictured at right are a few of the recommended surfaces.

As a homeowner, it is your responsibility to provide a suitable, level foundation for your spa. Keep in mind that most delivery crews are not equipped to level and prepare spa sites.

If you are interested in having a concrete slab, brick surface, or wood deck installed, your Hot Spot dealer should be able to suggest a qualified, licensed contractor.

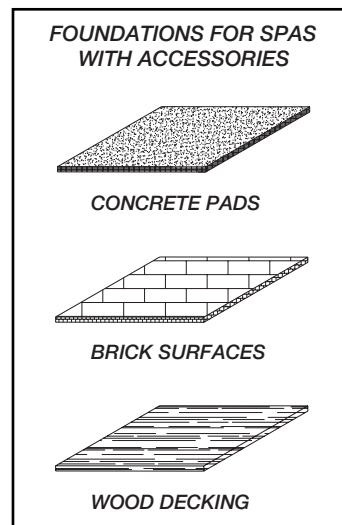
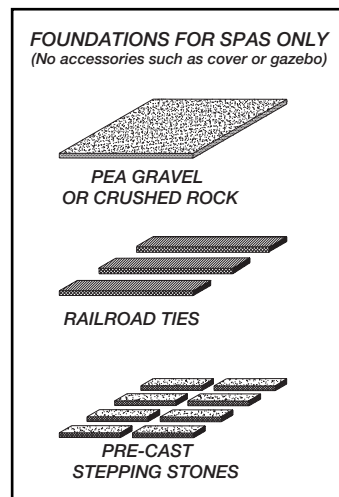

MALLORCA™ (Model MAL)

Dimensions

NOTE: All dimensions are approximate; measure your spa before making critical design or pathway decisions.

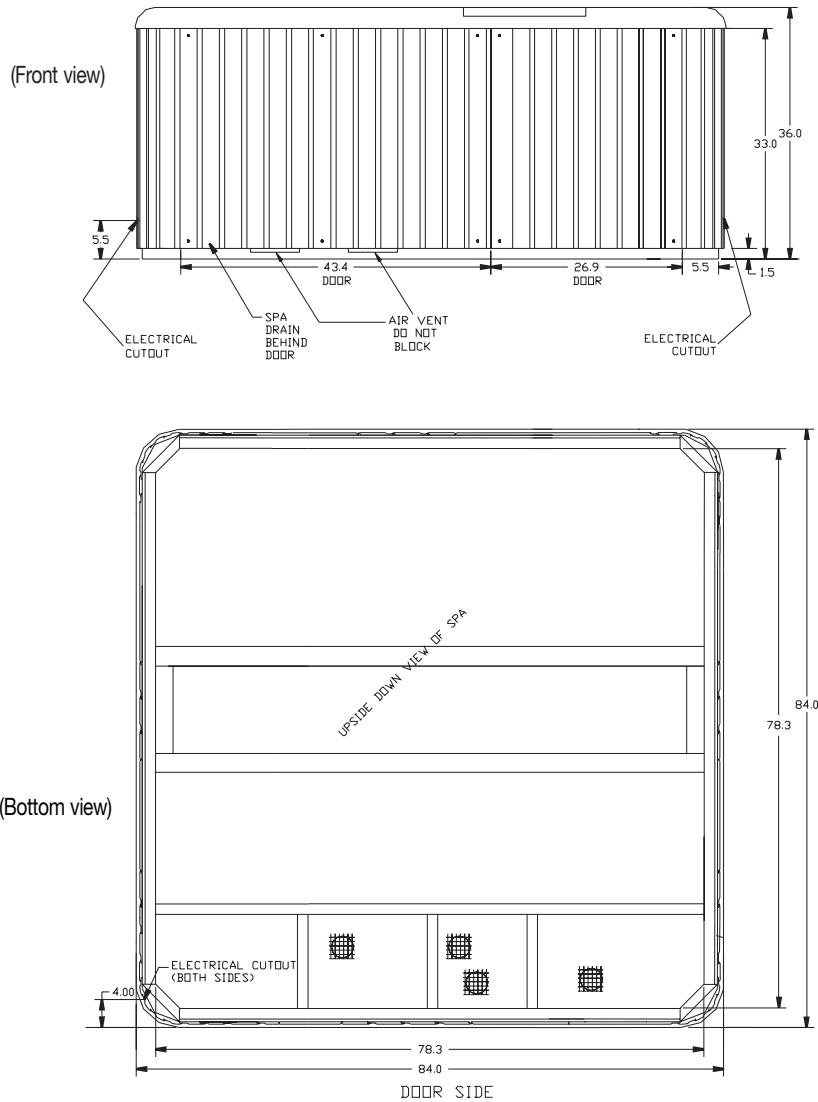

NOTE: Watkins Manufacturing Corporation recommends that the Mallorca be installed on a minimum 4" thick reinforced concrete pad or structurally sound deck able to support the "dead weight" found in the spa specification chart.

WARNING: The Mallorca must not be shimmed in any manner.

SORRENTO™ (Model SOR)

Dimensions

NOTE: All dimensions are approximate; measure your spa before making critical design or pathway decisions.

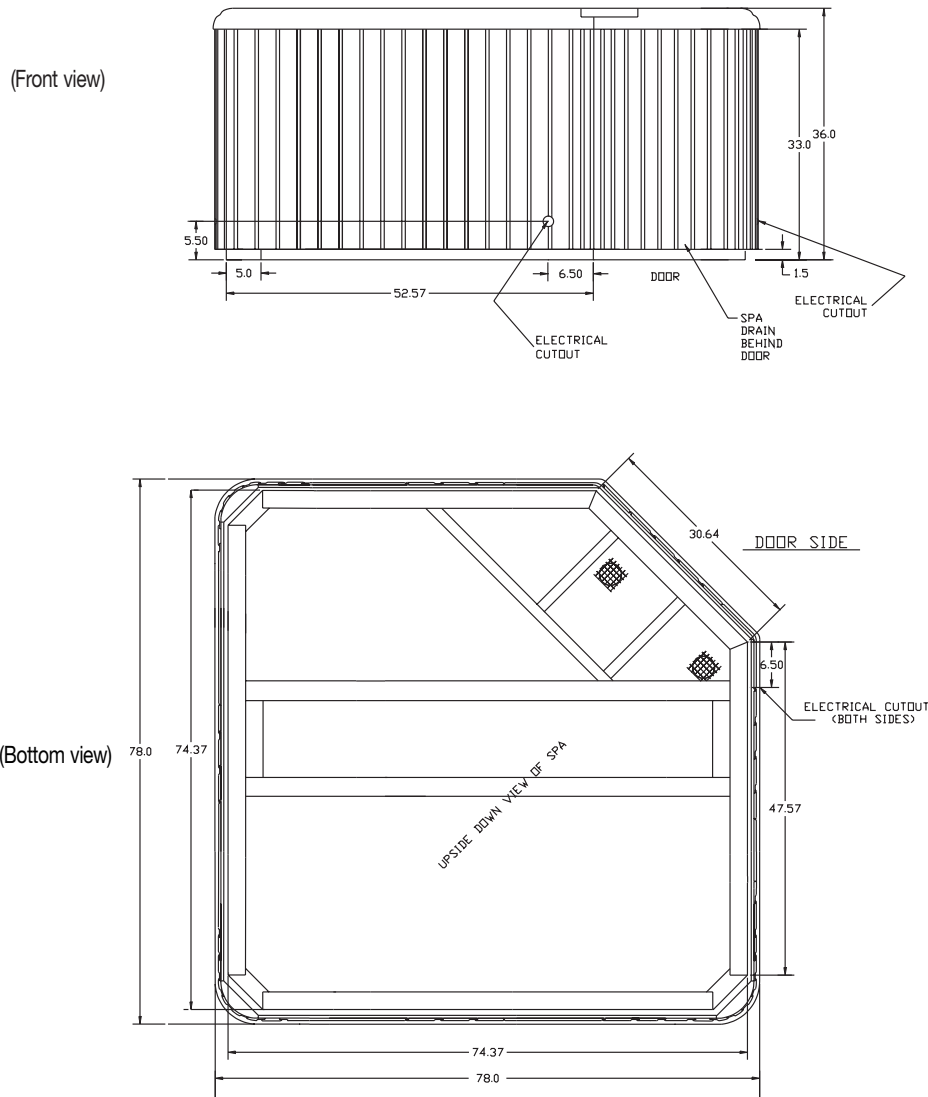

NOTE: Watkins Manufacturing Corporation recommends that the Sorrento be installed on a minimum 4" thick reinforced concrete pad or structurally sound deck able to support the "dead weight" found in the spa specification chart.

WARNING: The Sorrento must not be shimmed in any manner.

TRINIDAD™ (Model TRI)

Dimensions

NOTE: All dimensions are approximate; measure your spa before making critical design or pathway decisions.

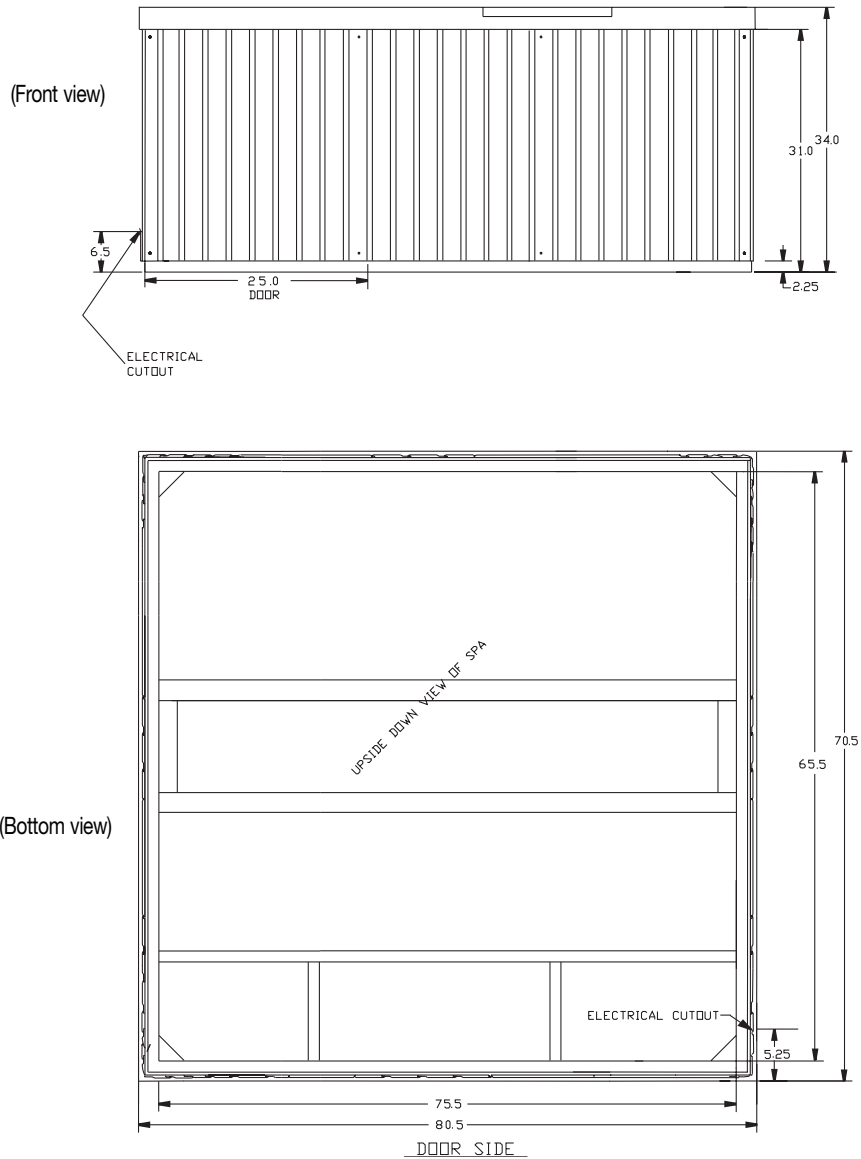

NOTE: Watkins Manufacturing Corporation recommends that the Trinidad be installed on a minimum 4" thick reinforced concrete pad or structurally sound deck able to support the "dead weight" found in the spa specification chart.

WARNING: The Trinidad must not be shimmed in any manner.

TOBAGO™ (Model TOB)

Dimensions

NOTE: All dimensions are approximate; measure your spa before making critical design or pathway decisions.

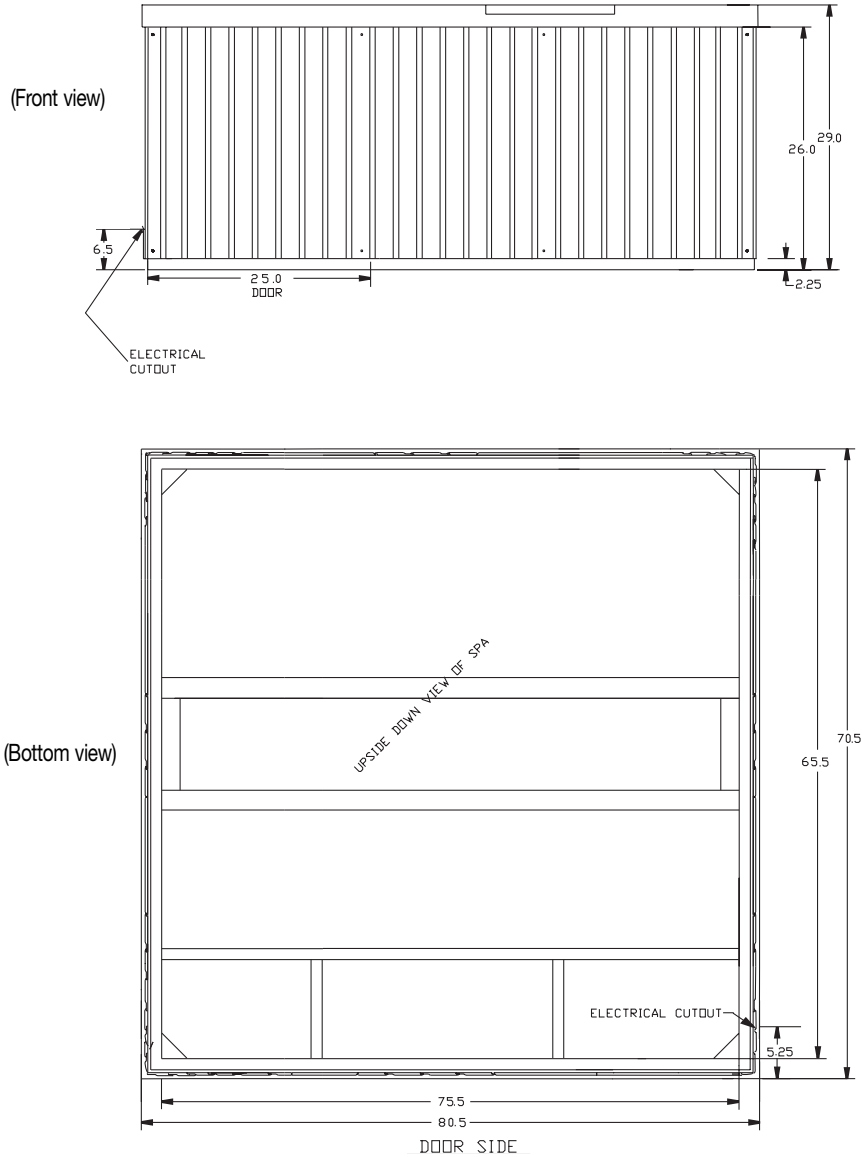

NOTE: Watkins Manufacturing Corporation recommends that the Tobago be installed on a minimum 4" thick reinforced concrete pad or structurally sound deck able to support the "dead weight" found in the spa specification chart.

WARNING: The Tobago must not be shimmed in any manner.

ELECTRICAL REQUIREMENTS

SELECTING THE VOLTAGE FOR YOUR SPA

Your spa is designed to operate at either 115 or 230 volts, 60 Hz unless it is the Mallorca™ model which requires a 230 volt power supply. When the spa is connected to 115 volts, the heater will provide approximately 1000 watts of heat only when the pump is operating in LOW speed and the thermostat is calling for heat. When the spa is connected to 230 volts, the heater will provide approximately 4000 watts of heat whether the pump is operating in LOW or HIGH speed and the thermostat is calling for heat.

All electrical connections must be made in accordance with the wiring information contained in the electrical control box or on the back of the field wiring access panel of the equipment module.

STANDARD, CORD-CONNECTED 115 VOLT 15 OR 20 AMP CONFIGURATION

For your safety, if you are having an electrician install an electric outlet for the spa it should be no closer than five (5) feet and no further than ten (10) feet from the spa. [Reference National Electrical Code 680 - 6a(1) and 680 - 41a.]

One GFCI is used in the cord-connected 15 or 20 amp configuration. The GFCI module is located at the end of the power cord. To test the GFCI, simply press the TEST button. The GFCI should trip to the “off” position, disconnecting power to the spa. To reset the GFCI, press the RESET button. The GFCI should reset, and power should be restored to the spa. If the GFCI does not function in this way, unplug the cord and contact an authorized Caldera spa service technician.

NOTE: Consult your local code authority to determine if an electrical outlet with a cover is required for your installation. If it is, a suitable outlet cover may be purchased from your authorized Hot Spot® dealer.

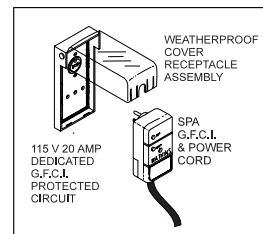
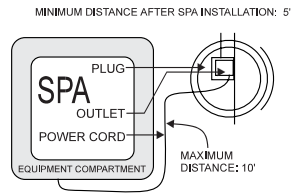

115 VOLT ELECTRICAL REQUIREMENTS

The spa must be connected to a 115 volt, 15 or 20 amp grounded circuit. The equipment pack requires a MINIMUM of 104 volts under load. A dedicated circuit is required; the term “dedicated” means the electrical circuit is not being used for any other high-load electrical items (patio lights, appliances, garage circuits, etc.). If the spa is connected to a non-dedicated circuit, overloading will result in “nuisance tripping” of the internal fuses or of the breaker switch at the house electrical breaker panel.

The circuit must be properly wired; that is, it must have the following:

- Standard (cord-connected) 115 volt 15 amp (Sorrento™ and Tobago™ models) – A minimum 15 amp GFCI circuit breaker in the house breaker panel, #14 AWG or larger wire (including the ground wire) and the correct polarity throughout the circuit.
- Standard (cord-connected) 115 volt 20 amp (Trinidad™ model) – A minimum 20 amp GFCI circuit breaker in the house panel, #12 AWG or larger wire (including the ground wire) and the correct polarity throughout the circuit.

In addition to the dedicated 20 amp, 115 volt GFCI protected circuit, your spa requires a 20 amp single receptacle. This receptacle, which contains an outdoor-rated, weather-resistant receptacle cover plate, will be provided to you. The single receptacle and cover plate should be installed by your electrician prior to the delivery of your spa.

A pressure wire connector is provided on the exterior surface of the spa’s electrical control box, located inside the equipment compartment. This is to permit the connection of a bonding ground wire between this point and any metal equipment, enclosures, pipe or conduit within five feet of the spa (if needed to comply with local building code requirements). The bonding wire must be at least a #10 AWG solid copper wire.

NEVER CONNECT THE SPA TO AN EXTENSION CORD!

Each Hot Spot® spa comes equipped with approximately 15 feet of usable power cord (this is the maximum length allowed by regulatory standards and the National Electric Code). The power cord is stored for shipping inside the equipment compartment. To remove the power cord, open the equipment compartment and locate the cord. Carefully pull the cord out of the equipment compartment to the desired length.

230 VOLT ELECTRICAL REQUIREMENTS

To ensure you will have an opportunity to use your spa soon after delivery, it is very important that the required electrical service has been installed. Unless otherwise stipulated by your dealer, **THIS IS YOUR RESPONSIBILITY.**

IMPORTANT: All electrical circuits must be installed by a qualified, licensed electrician. **When converting your spa from 115 volts to 230 volts, the power jumper between line two and neutral on the terminal block inside the control box must be removed.**

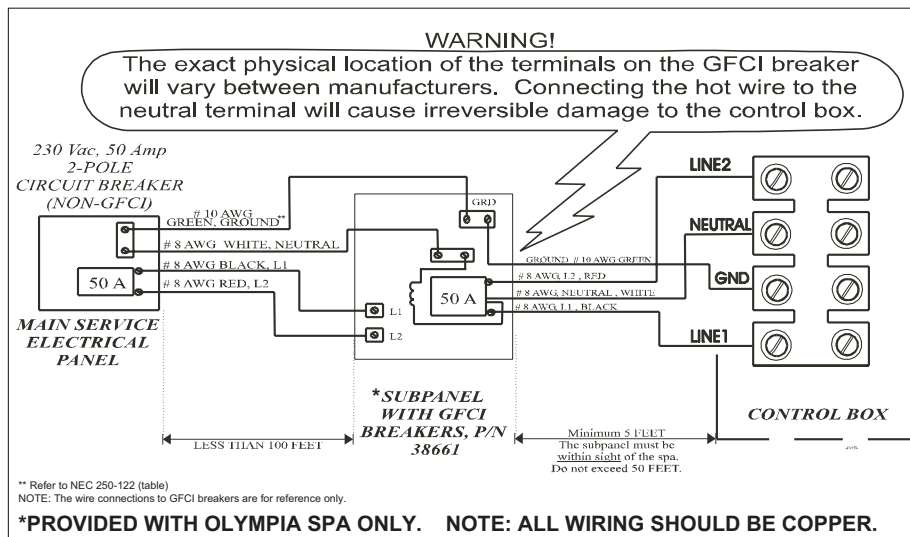

230 VOLT INSTALLATION

Your spa contains a control box designed to operate at 230V, 60Hz. Installation of a 50 amp. dedicated circuit is required. The control box must be hard wired directly to a subpanel protected by a Ground Fault Circuit Interrupter (GFCI). The subpanel containing GFCI breakers is included with the spa.

IMPORTANT NOTE: All electrical connections to the control box must be accomplished by a qualified electrician in accordance with the National Electrical Code and in accordance with any local electrical codes in effect at the time and place of installation.

All electrical connections must be made in accordance with the wiring information contained in this manual and on the back of the field wiring access panel of the control box. A licensed electrician should install a four-wire electrical service (two line voltages, one neutral, one ground) from the main electrical service panel to the subpanel.

The grounding conductor must be at least #10 AWG. Your electrician should mount the subpanel in the vicinity of the spa but it should not be closer than five (5) feet from the spa water edge (NEC 680-38 to 41-A-3).

INSTALLATION NOTE: After the spa has been installed, your electrician can connect the conduit from the subpanel to the spa's control box and then complete the wiring connections in the control box.

NOTE: Complete step-by-step Installation and Wiring Instructions for all models are included in the Owner's Manual and with each subpanel, which can be obtained from your dealer.

WARNING: Removing or bypassing the GFCI breakers in the subpanel at any time will result in an unsafe spa and will void the warranty.

POWER CONNECTION ACCESS

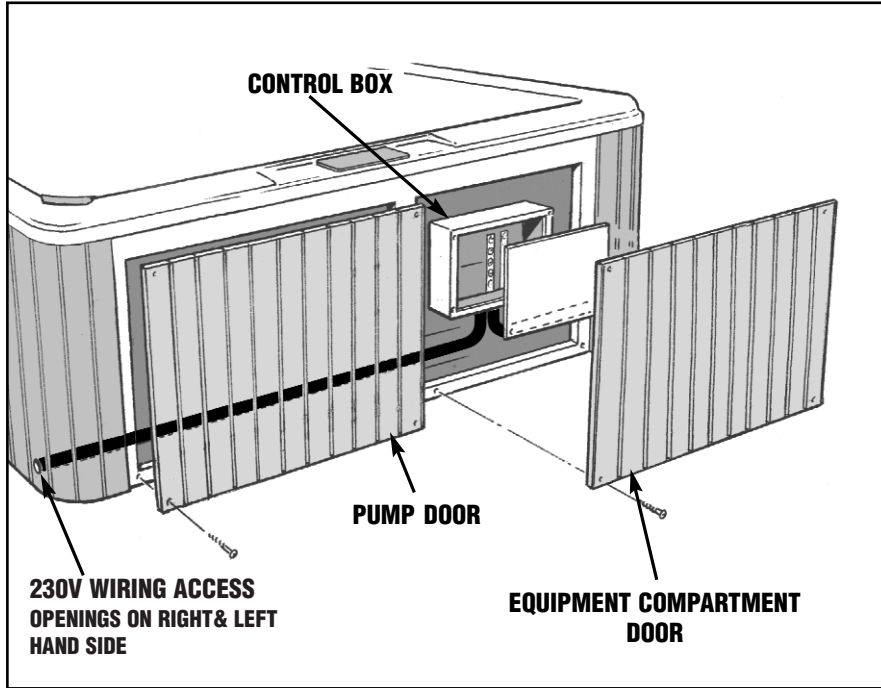

SPA SPECIFICATIONS CONTRACTOR SUGGESTIONS

Electrician

Name: _____

Telephone: _____

Name: _____

Telephone: _____

General

Name: _____

Telephone: _____

Name: _____

Telephone: _____

	Footprint dimensions	Height	Effective filter area	Heater (Watts)	Water capacity	Dry weight	Filled weight*	Dead weight*	Electrical Requirements
Mallorca (Model MAL)	7'0" x 7'0"	36"	75 Square feet	4,000	360 Gallons	706 Lbs.	4,744 Lbs.	100 Lbs. per square foot	230 volt, 50 amp Single phase GFCI circuit
Sorrento (Model SOR)	6'6" x 6'6"	36"	75 Square feet	1,000 or 4,000	280 Gallons	570 Lbs.	3,594 Lbs.	80 Lbs. per square foot	115 volt, 15 amp Dedicated GFCI protected cord or 230 volt, 50 amp Single phase GFCI circuit
Trinidad (Model TRI)	6'8" x 5'10"	34"	50 Square feet	1,000 or 4,000	290 Gallons	540 Lbs.	3,822 Lbs.	100 Lbs. per square foot	115 volt, 20 amp Dedicated GFCI protected cord or 230 volt, 50 amp Single phase GFCI circuit
Tobago (Model TOB)	6'8" x 5'10"	29"	50 Square feet	1,000 or 4,000	260 Gallons	482 Lbs.	3,515 Lbs.	90 Lbs. per square foot	115 volt, 15 amp Dedicated GFCI protected cord or 230 volt, 50 amp Single phase GFCI circuit

CAUTION: Watkins Manufacturing suggests a structural engineer or contractor be consulted before the spa is placed on an elevated deck.

* **NOTE:** The "Filled weight" and "Dead weight" of the spa includes the weight of the occupants (assuming an average occupant weight of 175 lbs).

ADDITIONAL PRODUCTS AVAILABLE FROM YOUR HOT SPOT® SPA DEALER

- EverFresh® water care system
- FreshWater® III high output ozone purification system
- Hot Spring® MPS chlorine-free oxidizer
- FreshWater® Stain and Scale Defense
- FreshWater Spa Shine
- FreshWater Instant Filter Cleaner
- FreshWater Filter Cleaner
- FreshWater Ph-Alkalinity Down
- FreshWater Ph-Alkalinity Up
- FreshWater Defoamer
- Hot Spring Cover Shield™
- MPS test strips
- Retractable cover system with clearance requirements
 - Cover Cradle® – 24" Clearance required
 - Cover Cradle II – 24" Clearance required
 - UpRite® – 7" Clearance required
 - GlideRite® – 14" Clearance required
- Vinyl covers
- Spa vacuums
- Stain kits
- Spa upgrade jet kits
- Replacement filter cartridges
- Pillows
- Others

SERVICES AVAILABLE FROM YOUR Hot Spot[®] SPA DEALER

Service

Cost

Pre-Delivery site inspection	_____
Deliver spa to installation site	_____
Unwrap spa and haul away packaging material	_____
Set up & level spa	_____
Fill the spa with water	_____
Connect the spa to its power source (115 volt 15 or 20 amp models)	_____
Explain and test the spa's operation	
• Jet system	
• Air Control system	
• Set temperature control	
• Control panel functions	
Explain the safety features	
• GFCI	
• Heater high limit	
General spa operation & maintenance orientation	_____
Water quality and maintenance orientation	_____
Adjust the water's Total Alkalinity, Calcium Hardness and pH	_____
Sanitize the water	_____
Inspect the spa cover, place on spa and install cover locks	_____
Review winterizing instructions	_____
Review Owner's Manual & Warranty Card	_____
Follow-up call	_____
In-store spa water analysis	_____
TOTAL COST	_____

Watkins[®]
The Home Relaxation Specialists

WATKINS MANUFACTURING CORPORATION
1280 Park Center Drive
Vista, California 92083
(800) 999-4688 extension 432

©2003 Watkins Manufacturing Corporation. Hot Spot, Comfort Control, Cover Cradle, UpRite, GlideRite, Cover Shield, EverFresh, FreshWater and The Home Relaxation Specialists are trademarks of Watkins Manufacturing Corporation.

Part #61965 Rev. A (2/03)

